



BYD Battery-Box Pro User Manual

Battery-Box Pro 13.8

Contents

1 General Information	3
1.1 Validity.....	3
1.2 Application.....	3
1.3 Intended use	3
1.4 Battery-Box definition.....	3
1.5 Identifying the Product	3
2 Safety.....	4
3 Technical Data	5
4 Technical Terms	6
5 Product Overview	6
5.1 Battery-Box System brief introduction	6
5.2 Battery-Box configuration table.....	7
5.3 General introduction of BMU	8
5.4 General introduction of Battery-Box 13.8 module	8
5.5 General introduction of BMS.....	8
5.6 Operating environment.....	9
6 Cleaning and Maintenance	9
6.1 Cleaning	9
6.2 Maintenance.....	9
6.2.1 Recharge requirement for normal storage.....	9
6.2.2 Recharge requirement when battery is over discharged	10
7 Compatible Inverter List	10
8 Common Issues and Solutions	10
8.1 Alarm indicated on the BMU and solution.....	10
8.2 Alarm display on BMS and solution.....	10
8.3 Common issues displayed on inverter and solution.....	12
8.4 Emergency	12
9 Warranty	12
Appendix 1: Minimum Configuration with Different Brands of Inverters	13
1 Minimum configuration with SMA Sunny Island inverter	13
2 Minimum configuration with GOODWE inverter	13
2.1 Minimum configuration with ES.....	13
2.2 Minimum configuration with BP.....	14
2.3 Minimum configuration with EM.....	14

2.4 <i>Minimum configuration with SBP</i>	14
3 Minimum configuration with Victron inverter	15
3.1 <i>Minimum configuration with Multiplus</i>	15
3.2 <i>Minimum configuration with Multigrid</i>	15
3.3 <i>Minimum configuration with Quattro</i>	15
3.4 <i>Minimum configuration with Easysolar with CCGX</i>	16
4 Minimum configuration with Sungrow inverter	17
4.1 <i>Minimum configuration with SH5K</i>	17
5 Minimum configuration with Selectronic inverter	17
5.1 <i>Minimum configuration with SP PRO</i>	17
5.2 <i>Minimum configuration with SP PRO for 3 phase</i>	17
6 Minimum configuration with Imeon inverter	18
7 Minimum configuration with Solis inverter	18
Appendix 2: Common Failures Displayed on Inverter and Solutions	19
1 Alarm code displayed on the SRC of SMA sunny island and solution	19
2 Alarm displayed on the APP of GOODWE and solution	19
Contact Information	

1 General Information

1.1 Validity

This user manual applies to the Battery-Box Pro 13.8.

1.2 Application

This user manual introduces the Battery-Box product information, using guidance, safety, common issues and actions.

The Battery-Box Pro 13.8 is an energy storage unit that can be used in ON-grid system or Off-grid system.

The product is suitable for indoor use only.

1.3 Intended use

The Battery-Box is not suitable for supplying life-sustaining medical devices. A power outage must not lead to personal injury.

Use this product only in accordance with the information provided in the enclosed documentation and with the locally applicable standards and directives. Any other application may cause personal injury or property damage.

The illustrations in this manual meant only to help explain system configuration concepts, includes using guidance, safety caution and normal failure and actions.

Alterations to the product, e.g. changes or modifications, are only permitted with the express written permission of BYD. Unauthorized alterations will void warranty claims. BYD shall not be held liable for any damage caused by such changes. Any use of the product other than that described in the Intended use section does not qualify as appropriate. The enclosed documentation is an integral part of this product. Keep the documentation in a convenient place for future reference and observe all instructions contained therein. The type label must be attached to the product.

Battery-Box Pro 13.8 must work with compatible inverters which are listed in the "Compatible inverter list" in this manual.

1.4 Battery-Box definition

BYD Battery-Box products Battery-Box Pro 13.8 is defined as below:

Battery-Box Pro 13.8: the name of Battery Box system with the usable energy of 13.8kWh.

1.5 Identifying the Product

The Type Label describes the product identification, which is attached on the product.

The Type Label includes following information:

Product Name:

Product Type:

Nominal Capacity:

Nominal Voltage:

Max Charging & Discharging Current:

Operating Temperature Range:

2 Safety

This section contains safety information that must be observed at all times when working on or with batteries. To prevent personal injury or property damage and to ensure long-term operation of the batteries, read this section carefully and observe all safety information at all times.



WARNING

Environmental requirement

Do not expose the battery to temperature above 50°C.

Do not place the battery near any heat sources.

Do not expose the battery to moisture or liquids.

Do not expose the battery to the corrosive gases or liquids.

Do not expose the battery to direct sunlight

Place battery in secure location away from children and animals.

Do not allow the battery power terminals to touch conductive objects such as wires.

Operation

Do not disassemble the battery.

Do not touch the battery pack with wet hands.

Do not crush, drop or puncture the battery.

Always dispose according to local safety regulations.

Store and recharge battery according to user manual strictly.

Ensure reliable grounding.

Do not reverse polarity

Do not short circuit the terminals, remove all jewelry items that could product a short circuit.

Disconnect battery from power and load, then power off battery before installation and maintenance.

Do not stack up batteries without package.

The packed batteries are not allowed to be stacked up more than specified layers stipulated on the package.

Continuous operation on a damaged battery can result in dangerous situation that may cause severe injury due to electrical shock.

3 Technical Data

Model	Battery-Box Pro 13.8
Battery type	Lithium Ion Battery
Battery module ^[1] [kWh]	13.8
Usable Energy ^[1] [kWh]	13.8
Max Output Power [kW]	12.8
Peak Output Power [kW]	13.3, 60s
Round-Trip Efficiency	≥95.3% (Under test condition [1])
Nominal Voltage [Vd.c]	51.2
Operating Voltage Range [Vd.c]	40 ~ 56.5
Communication	RS485 / CAN
Dimension [W × H × D, mm]	650 × 800 × 550
Net Weight [kg]	181
Enclosure Protection Rating	IP20
Ambient Temperature Range ^[2] [°C]	-10 ~ +50
Certification & Safety Standard	TUV(IEC62619) / CE / RCM / UN38.3
Scalability	Max. 32 systems in parallel
Compatible Inverters	Please refer to the Minimum Configuration with Different Brands of Inverters

[1].Test conditions: 100% DOD, 0.2C charge & discharge @+25°C

[2]. -10°C~12°C will be derating

* System Usable Energy may be variant with different inverter brands

Note: The maximum operating voltage of the rechargeable lithium-ion battery system is less than 60Vd.c

When Battery-Box works in different temperatures, the current of charge and discharge will be adjusted automatically, battery will permit lower current when operating temperature gets lower. Please refer to below table for the detail parameters setting:

Parameter setting of charging current in various temperatures	
Operating temp. (°C)	Normal current(Ad.c)
-10~2	15*N
2~12	42.5*N
12~50	175*N

Remark:

1. Effective time is 2mins when changing from one temperature range to another.

2. N= battery quantity

Parameter setting of discharging current in various temperatures	
Operating temp. (°C)	Normal current(Ad.c)
-10~50	125~250*N

Remark: N= battery quantity

4 Technical Terms

No.	Term	Comment
1	Discharge	Battery output power for load
2	Charge	To put electricity into battery by charger
3	Full charged	Battery had been full charged, SOC is 100%.
4	Idle	Battery is on status of neither charge nor discharge and has not been fully charged.
5	Shutdown mode	Power off
6	SOC	State of Charge
7	SW	Software
8	HW	Hardware
9	Battery voltage	The voltage between B+/B-
10	Pack voltage	The voltage between P+/P-
11	Cell voltage	Single cell voltage
12	Failure	Battery or BMS are broken, and unit needs to be replaced
13	Alarm	Battery will stop charging or discharging immediately
14	Protect	Battery stops charging or discharging (e.g. cell is overvoltage). Operation can resume at a later stage.
15	Over discharged	Battery module or batteries overvoltage, need to be recharged timely

5 Product Overview

5.1 Battery-Box System brief introduction

The Battery-Box energy storage system combined with high-performance BYD lithium battery, consists of cabinet, battery, BMS and BMU. Each set of the storage system includes 2 battery modules connected in series, and up to 32 Battery-Box 13.8 energy storage system can be connected in parallel.

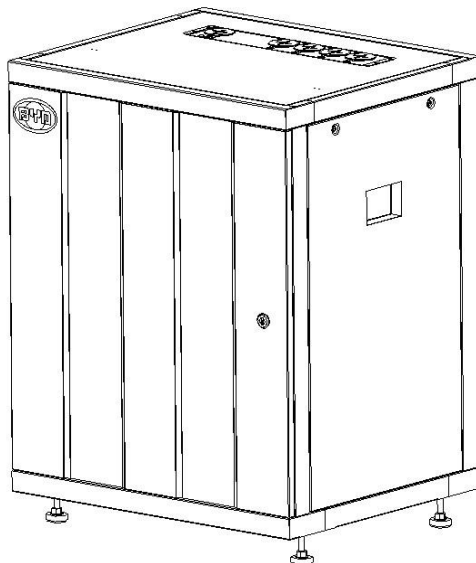

External drawing

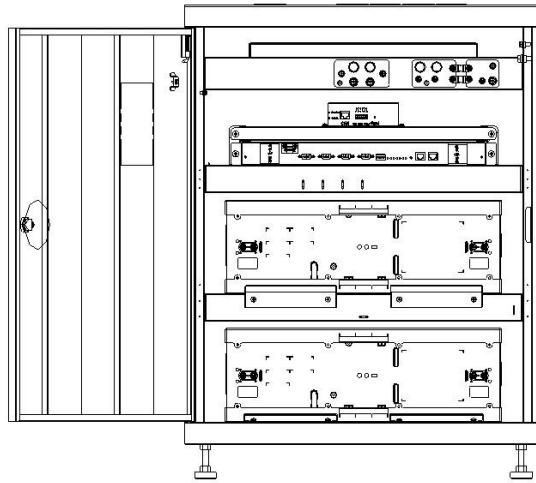

Internal drawing

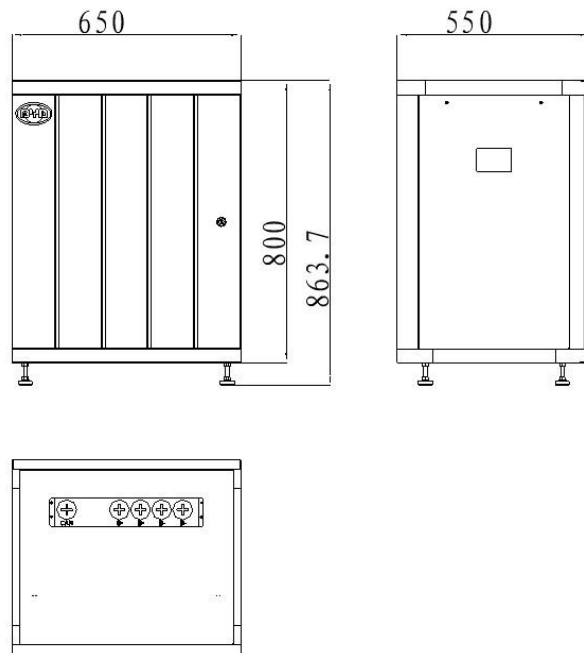

Structure dimension drawing

5.2 Battery-Box configuration table

No.	Component	Name	Description
1	Cabinet	Battery Box Cabinet	The cabinet is used to accommodate these 2 modules and provide DC input and output.
2	Battery	Battery module	Battery module with 51.2V 270Ah, BYD' s P/N is: GBSSB
3	BMU	BMU	Battery management unit. Provides communication with external equipment.
4	BMS	BMS	Battery module management unit and communicate with BMU

5.3 General introduction of BMU

BMU is the battery management unit installed in the cabinet; its function is to manage the battery' s charging and discharging, collect information from the battery and report to the inverter.

Main functions:

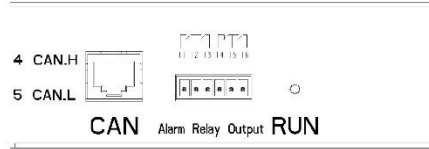

- ✓ CAN / RS485 communication with inverter
- ✓ RS485 communicate with battery/BMS
- ✓ Other Communication interface for maintenance
- ✓ Charge and discharge management

5.4 General introduction of Battery-Box 13.8 module

Battery-Box Pro 13.8 includes two battery modules, one battery modules is 25.6V/270Ah, and the batteries are in series connection.

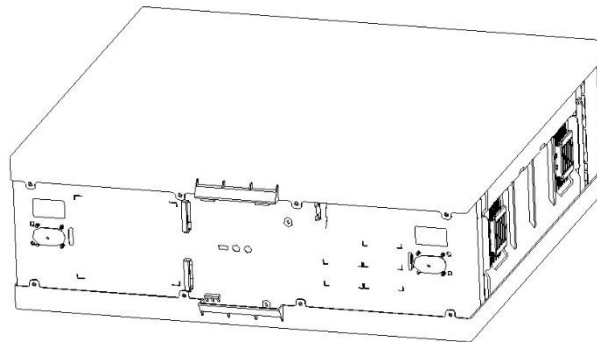

Module overview

5.5 General introduction of BMS

BMS, the battery management system, manages battery' s charging and discharging, and communicates with BMU, also it reports warning and alarm information to external equipment to make sure that the system run normally.

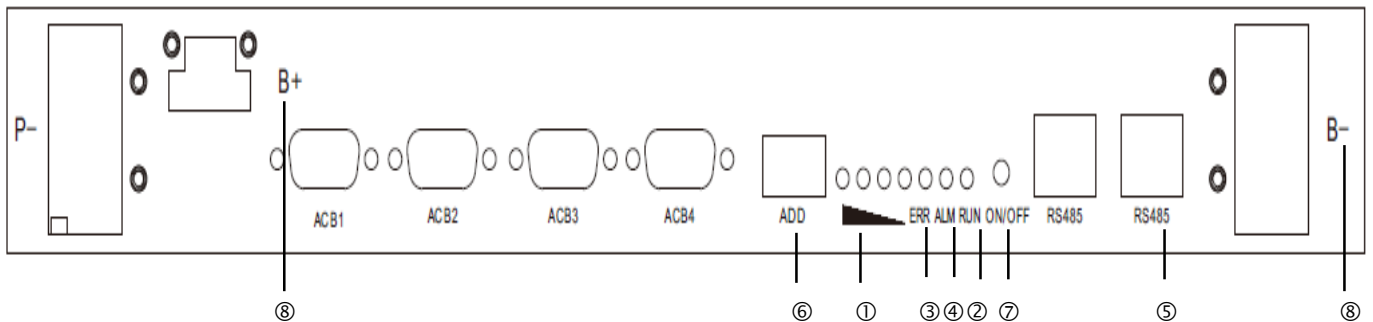

Display and communication interface

No.	Interface	Mark	
①	SOC LED	SOC	Indicate current SOC of battery
②	RUN LED	RUN	Indicate that the Battery is in running status
③	ERR LED	ERR ADDR	Indicate error status
④	ALM LED	Alarm	Indicate alarm status
⑤	RJ45 terminal	RS485	Communication ports
⑥	Address	ADDR	Address needs to be set, if they are connected in parallel.
⑦	ON/OFF	ON/OFF	Power on/power off manually
⑧	Test terminal	B- B+	Measure battery voltage when testing.

5.6 Operating environment

Operating environment parameters

No.	Item	Min.	Typical	Max.	Unit	Remark
1	Discharging temperature	-10	25	50	°C	
2	Charging temperature	-10	25	50	°C	
3	Relative humidity	5		95	%	
4	Absolute humidity	0.26		25	g/m ³	
5	Elevation	-	2000	-	m	
6	Enclosure			IP20		

6 Cleaning and Maintenance

6.1 Cleaning



CAUTION:

Please power off the system before cleaning the Battery-Box Pro 13.8

The Battery-Box system is recommended to be cleaned periodically. If the enclosure is dirty, please use a soft, dry brush or a soot blower to remove the dust. Liquids such as solvents, abrasives or corrosive liquids are not allowed to clean the enclosure.

6.2 Maintenance

6.2.1 Recharge requirement for normal storage

Batteries should be stored in position with the temperature range of $-20^{\circ}\text{C} \sim +45^{\circ}\text{C}$, and maintained regularly according to the following table with 0.5C (125A) current for 1 hour after a long time of storage.

Recharge conditions when in storage

Storage environment temperature	Relative humidity of storage environment	Storage time	SOC
Below -20°C	/	Avoid	/
-20~25°C	5%~70%	≤12 months	30%≤SOC≤60%
25~35°C	5%~70%	≤6months	30%≤SOC≤60%
35~45°C	5%~70%	≤3months	30%≤SOC≤60%
Above 45°C	/	Avoid	/

6.2.2 Recharge requirement when battery is over discharged

Please recharge the over discharged batteries in time as per the following table, otherwise the over discharged ones will be damaged.

Recharge condition when battery is over discharged

Storage environment temperature	Storage time
-20~25°C	≤15 days
25~45°C	≤7 days

7 Compatible Inverter List

To make sure that the system can be operated normally, please use BYD compatible inverters and select battery quantity correctly, according to the “Minimum Configuration with Different Brands of Inverters” in Appendix 1 in this user manual.

8 Common Issues and Solutions

8.1 Alarm indicated on the BMU and solution

LED of the BMU	Possible cause	Solution
Flash 1 time	Inverter and BMU communication failure	Step1. Check whether the CAN communication cable has been connected correctly and tightly ; Step2. If the connection is incorrect, please reconnect the cable correctly; if the connection is correct and reliable, then replace the BMU ;
Flash 2 times	Battery not found	Check the connection between BMU and first battery.
Flash 3 times	One or some batteries are disconnected	1. Check RS485 cable and battery address 2. If the connection and the address are correct, please contact the after service provider
Flash 4 times	Any battery failure	Check battery led status. If the red led is on and buzzer alarms, please contact the after service provider to replace the battery.

8.2 Alarm display on BMS and solution

Alarm indicated by flashing LED

Info Battery displayed	Flash	Possible cause	Solution
Only yellow led is ON 	0.5Hz	Battery was powered off abnormally;	Press ON/OFF button for 2-3 seconds to restart the battery, If the battery cannot be recovered, contact the after service provider immediately;
Flow led flashes and alternates with capacity led	10s per cycle	Communication connection timeout	Step1.Check the communication wire/cable Step2.Check battery address
NO.1/3 led and No.2/4 led flashing alternately	/	Update status	If the firmware is not updated, then reset the battery.

Alarm indicated by flashing yellow Led

Fault phenomenon	Flashing Times	Possible causes	Solution
1.Yellow led (Alarm) is always on 2 Press on/off button for 1S and release, then hear short buzzer 3. The green Led (RUN) is always on, and yellow led (ALM) flash at different times, which indicates that battery is in alarm status.	1time	Under voltage (BAT or CELL)	Contact the after service provider
	2times	Over charge	Contact the after service provider
	3times	Low temperature charge over-current	Contact the after service provider
	4times	Charge short circuit	Contact the after service provider
	5times	Discharge short circuit	Contact the after service provider
	6times	Parallel short circuit	Contact the after service provider
	7times	Discharge over-current protection	Contact the after service provider
	8times	High temperature protection	Contact the after service provider
	9times	Low temperature protection	Contact the after service provider
	10times	PACK over voltage protection	Contact the after service provider

Alarm status indicated by flashing red led

Fault phenomenon	Times	Possible cause	Solution
1.Red led (Err) is always on 2. Press the on/off button press the for1S and released, then buzzer sounds shortly 3. Green led (RUN) is always on, and red led (ERR) is flashing, which shows the alarm status.	1time	Voltage sensor failure	Replace the battery
	2times	Temperature sensor failure	Replace the battery
	3times	Charging circuit failure	Replace the battery
	4times	Discharge circuit failure	Replace the battery
	5times	Batteries failure	Replace the battery
	6times	Communication failure	Replace the battery

Failures indicated by buzzer			
Fault phenomenon	Times	Possible cause	Solution
The buzzer sounds with different times at a 15 seconds interval.	4times	Reverse 、 short circuit	1.Power off; 2.Inspect short/reverse connection of cable between P+&P-; 3.If short/reverse connection is confirmed, please reconnect cable correctly; 4.Restart battery;
	3times	Batteries failure	Replace the battery
	2times	Voltage sensor failure、 Temperature sensor failure	Replace the battery
	1time	Charging/Discharge circuit failure	Replace the battery

8.3 Common issues displayed on inverter and solution

User also can check the battery' s running, warning and alarm information from App or LED display of inverter, detail information please refer to Appendix 2 in this user manual.

8.4 Emergency

Please cut off the power supply and turn off the battery in emergency.

9 Warranty

BYD provides warranty when the product is installed and used according to the description of user manual / installation manual / warranty letter.

1. Please contact our local service provider for technical support & after service.
2. Please download the Warranty Letter via following website:

Australia customer: www.alpspower.com.au

European customer: www.eft-systems.de

Appendix 1: Minimum Configuration with Different Brands of Inverters

1 Minimum configuration with SMA Sunny Island inverter

Inverter Firmware version: minimum required firmware version for SI is V1.73.

Battery-Box firmware version: minimum required firmware version for BMU is V2.7.

1 Phase on Grid

Inverter Type	Battery-Box 13.8
SI 3.0M	≥1
SI 4.4M	≥1
SI 6.0H	≥1
SI 8.0H	≥1

3 Phase on Grid

Inverter Type	Battery-Box 13.8
SI 3.0M	≥1
SI 4.4M	≥1
SI 6.0H	≥1
SI 8.0H	≥1

1 Phase off Grid

Inverter Type	Battery-Box 13.8
SI 3.0M	≥1
SI 4.4M	≥1
SI 6.0H	≥1
SI 8.0H	≥1

3 Phase off Grid

Inverter Type	Battery-Box 13.8
SI 3.0M	≥2
SI 4.4M	≥2
SI 6.0H	≥3
SI 8.0H	≥3

Remark: Maximum quantity of Battery-Box 13.8 is 32.

2 Minimum configuration with GOODWE inverter

2.1 Minimum configuration with ES

Inverter Firmware version: minimum required firmware version for ARM is 03.

Battery-Box firmware version: minimum required firmware version for BMU is V4-10.

1 Phase on Grid

Inverter Type	Battery-Box 13.8
---------------	------------------

GW3648D-ES	$\geq 1^1$
GW5048D-ES	≥ 1
1 Phase off Grid	
Inverter Type	Battery-Box 13.8
GW3648D-ES	≥ 1
GW5048D-ES	≥ 1
Remark: Maximum quantity of Battery-Box 13.8 is 32.	

2.2 Minimum configuration with BP

Inverter Firmware version: minimum required firmware version for ARM is 03.

Battery-Box firmware version: minimum required firmware version for BMU is V4-10.

1 Phase on Grid	
Inverter Type	Battery-Box 13.8
GW2500-BP	≥ 1
Remark: Maximum quantity of Battery-Box 13.8 is 32.	

2.3 Minimum configuration with EM

Inverter Firmware version: minimum required firmware version for ARM is 03.

Battery-Box firmware version: minimum required firmware version for BMU is V4-10.

1 Phase on Grid	
Inverter Type	Battery-Box 13.8
GW3048-EM	≥ 1
GW3648-EM	≥ 1
GW5048-EM	≥ 1
1 Phase off Grid	
Inverter Type	Battery-Box 13.8
GW3048-EM	≥ 1
GW3648-EM	≥ 1
GW5048-EM	≥ 1
Remark: Maximum quantity of Battery-Box 13.8 is 32.	

2.4 Minimum configuration with SBP

Inverter Firmware version: minimum required firmware version for ARM is 03.

Battery-Box firmware version: minimum required firmware version for BMU is V4-10.

1 Phase on Grid	
Inverter Type	Battery-Box 13.8
GW3600S-BP	≥ 1
GW5000S-BP	≥ 1
Back-up mode	
Inverter Type	Battery-Box 13.8
GW3600S-BP	≥ 1
GW5000S-BP	≥ 1

¹ This configuration is only for self-consumption application

Remark: Maximum quantity of Battery-Box 13.8 is 32.

3 Minimum configuration with Victron inverter

3.1 Minimum configuration with Multiplus

Inverter Firmware version: minimum required firmware version for CCGX is V2.01.

Battery-Box firmware version: minimum required firmware version for BMU is V4-17.

1 Phase on Grid

Inverter Type	Battery-Box 13.8
48/3000/35	≥1
48/5000/70	≥1

3 Phase on Grid

Inverter Type	Battery-Box 13.8
48/3000/35	≥2
48/5000/70	≥2

1 Phase off Grid

Inverter Type	Battery-Box x 13.8
48/3000/35	≥1
48/5000/70	≥1

3 Phase off Grid

Inverter Type	Battery-Box 13.8
48/3000/35	≥2
48/5000/70	≥3

Remark: Maximum quantity of Battery-box 13.8 is 32.

3.2 Minimum configuration with Multigrid

Inverter Firmware version: minimum required firmware version for CCGX is V2.01

Battery-Box firmware version: minimum required firmware version for BMU is V4-17.

1 Phase on Grid

Inverter Type	Battery-Box 13.8
48/3000/35	≥1

3 Phase on Grid

Inverter Type	Battery-Box 13.8
48/3000/35	≥2

1 Phase off Grid

Inverter Type	Battery-Box 13.8
48/3000/35	≥1

3 Phase off Grid

Inverter Type	Battery-Box 13.8
48/3000/35	≥2

Remark: Maximum quantity of Battery-box 13.8 is 32.

3.3 Minimum configuration with Quattro

Inverter Firmware version: minimum required firmware version for CCGX is V2.01.

Battery-Box firmware version: minimum required firmware version for BMU is V4-17.

1 Phase on Grid	
Inverter Type	Battery-Box 13.8
48/5000/70-100/100	≥1
48/8000/110-100/100	≥1
48/10000/140- 100/100	≥1
48/15000/200- 100/100	≥1
3 Phase on Grid	
Inverter Type	Battery-Box 13.8
48/5000/70-100/100	≥2
48/8000/110-100/100	≥2i
48/10000/140- 100/100	≥2
48/15000/200- 100/100	≥3
1 Phase off Grid	
Inverter Type	Battery-Box 13.8
48/5000/70-100/100	≥1
48/8000/110-100/100	≥2
48/10000/140- 100/100	≥2
48/15000/200- 100/100	≥3
3 Phase off Grid	
Inverter Type	Battery-Box 13.8
48/5000/70-100/100	≥3
48/8000/110-100/100	≥5
48/10000/140- 100/100	≥6
48/15000/200- 100/100	≥7

Remark: Maximum quantity of Battery-box 13.8 is 32.

3.4 Minimum configuration with Easysolar with CCGX

Inverter Firmware version: minimum required firmware version for CCGX is V2.01.

Battery-Box firmware version: minimum required firmware version for BMU is V4-17.

1 Phase on Grid	
Inverter Type	Battery-Box 13.8
48/3000/35-50 MPPT150/70	≥1
48/5000/70-100 MPPT150/100	≥1
3 Phase on Grid	
Inverter Type	Battery-Box 13.8
48/3000/35-50 MPPT150/70	≥1
48/5000/70-100 MPPT150/100	≥1
1 Phase off Grid	
Inverter Type	Battery-Box 13.8
48/3000/35-50 MPPT150/70	≥1
48/5000/70-100 MPPT150/100	≥1
3 Phase off Grid	

Inverter Type	Battery-Box 13.8
48/3000/35-50 MPPT150/70	≥2
48/5000/70-100 MPPT150/100	≥3

Remark: Maximum quantity of Battery-box 13.8 is 32.

4 Minimum configuration with Sungrow inverter

4.1 Minimum configuration with SH5K

Inverter Firmware version: minimum required firmware version is V13.

Battery-Box firmware version: minimum required firmware version for BMU is V4-17, identification label on package: V2.2

1 Phase on Grid

Inverter Type	Battery-Box 13.8
SH5K	≥1

1 Phase off Grid

Inverter Type	Battery-Box 13.8
SH5K	≥1

Remark: Maximum quantity of Battery-box 13.8 is 32

5 Minimum configuration with Selectronic inverter

5.1 Minimum configuration with SP PRO

Inverter Firmware version: minimum required firmware version is V0.27.

Battery-Box firmware version: minimum required firmware version for BMU is V4-17, identification label on package: V2.2

1 Phase on Grid

Inverter Type	Battery-Box 13.8
SPMC481-AU	≥1
SPMC482-AU	≥1

1 Phase off Grid

Inverter Type	Battery-Box 13.8
SPMC481-AU	≥1
SPMC482-AU	≥2

Remark: Maximum quantity of Battery-box 13.8 is 32.

5.2 Minimum configuration with SP PRO for 3 phase

Inverter Firmware version: minimum required firmware version is 11.06.

Battery-Box firmware version: minimum required firmware version for BMU is V4-22.

3 Phase on Grid

Inverter Type	Battery-Box 13.8
SPMC481	≥1
SPMC482	≥1

3 Phase off Grid

Inverter Type	Battery-Box 13.8
SPMC481	≥5
SPMC482	≥8

Remark: Maximum quantity of Battery-box 13.8 is 32.

6 Minimum configuration with Imeon inverter

Inverter Firmware version: minimum required firmware version is 1.7.7.8.

Battery-Box firmware version: minimum required firmware version for BMU is V4-22. Identification label on package is V2.4

On Grid

Inverter Type	Battery-Box 13.8
IMEON 3.6	≥1
IMEON 9.12	≥1

Off Grid

Inverter Type	Battery-Box 13.8
IMEON 3.6	≥1
IMEON 9.12	≥1

Remark: Maximum quantity of Battery-Box 13.8 is 32.

7 Minimum configuration with Solis inverter

Inverter Firmware version: minimum required firmware version is 11000F.

Battery-Box firmware version: minimum required firmware version for BMU is V4-22.

Shall bypass main circuit breaker when the system is off grid application.

1 Phase on grid

Inverter Type	Battery-Box 13.8
RHI-3K-48ES	≥1
RHI-3.6K-48ES	≥1
RHI-4.6K-48ES	≥1
RHI-5K-48ES	≥1

1 Phase off grid

Inverter Type	Battery-Box 13.8
RHI-3K-48ES	≥1
RHI-3.6K-48ES	≥1
RHI-4.6K-48ES	≥1
RHI-5K-48ES	≥1

Remark: Maximum quantity of Battery-box 13.8 is 32.

Appendix 2: Common Failures Displayed on Inverter and Solutions

1 Alarm code displayed on the SRC of SMA sunny island and solution

SMA SRC	Possible causes	Solution
F221	External Alarm-Invalid Bat Type	Reset battery type to "Li" on SRC.
F920(XA01General)	1.Any battery module has failed to communicate with the BMU; 2.RS485communication between the BMU and the battery module is failed;	1.Check if the RS485 communication cable has been connected correctly and tightly ; 2.Check DIP switch setting according to the setting of DIP switch guidance in user manual; 3.Change BMU inside the cabinet ;
F921(XA02DcHiVolt)	External Alarm - Battery High Voltage	If the red led is on, please contact the service provider to change the battery. If not, check the system setting according to the guidelines.
F922(XA03DcLoVolt)	External Alarm - Battery Low Voltage	
F923(XA04DcHiTmp)	External Alarm - Battery High Temp	
F924(XA05DcLoTmp)	External Alarm - Battery Low Temp	
F925(XA06DcHiTmpC)	External Alarm - Battery High Temp Charge	
F926(XA07DcLoTmpC)	External Alarm - Battery Low Temp Charge	
F927(XA08DcHiCur)	External Alarm - Battery High Current Discharge	
F928(XA09DcHiChgCur)	External Alarm - Battery High Current Charge	
F930(XA11Short)	External Alarm - Short circuit	1.Power off; 2.Check if there is short connection of cable between P+&P-; 3.If short connection is confirmed, please reconnect cable correctly; 4.Restart battery;
F931(XA12Bms)	External Alarm - BMS internal	If the red led is on, please contact the service provider to change the battery. If not, check the system settings according to the guidelines.
F932(XA13CellBal)	External Alarm - Cell imbalance	
F952	External Alarm –Ext BMS Timeout	1.Check whether the CAN communication cable has been connected correctly and tightly ; 2.Change BMU inside the cabinet;

2 Alarm displayed on the APP of GOODWE and solution

APP of GOODWE	Possible causes	Solution
---------------	-----------------	----------

BMS status: Battery
communication fail

Inverter and BMU
communication failure

1. Check whether the CAN communication cable has been connected correctly and tightly ;
 2. Change BMU inside the cabinet;
-

Contact Information

China

BYD LITHIUM BATTERY Co., LTD

E-Mail: eubatterygrp@byd.com

Tel: +86 0755 89888888

Fax: 0755-8961 9653

Address: No.1 Baoping Road, Baolong Industrial Town, Longgang Shenzhen,
518116, China

Local contacts :

Australia

Alps Power Pty Ltd

Address: 14/47-51 Lorraine St Peakhurst NSW 2114

Customer Service Mailbox: service@alpspower.com.au

Telephone: +61 2 8005 6688

Website: www.alpspower.com.au

Europe

EFT-Systems GmbH

Address: Buchenstr.37 97816 Lohr a. Main

Customer Service Mailbox: service@eft-systems.de

Telephone: +49 9352 8523999(DE)

+34 91 0602267 (ES)

+39 02 87368364 (IT)

+44 2037695998 (UK)

Website: www.eft-systems.de