



B-Box H 6.4~11.5
User Manual

Rev.1.0_Aug.2017

Copyright © BYD Company Limited. All rights reserved.

Without BYD's prior written permission, no entity and individual shall extract or copy part or all of the content of this document or disseminate it in any form.

Statement:

The content of this Manual may be adjusted due to the update of product version or other reason only when it is notified by BYD. Unless otherwise agreed, this document is only used as the guidance for use, and all statements, information and suggestions in this document don't constitute any explicit or implied guarantee.

If you have any question, please contact us through the after-sales service website.

BYD Co., Ltd.

Tel.: 0755-8988 8888

Fax: 0755-8961 9653

Contents

1 Overview	4
1.1 About this Manual	4
1.2 Target Products	4
1.3 Usage	4
1.4 B-Box HV Definitions	4
1.5 Product Identification	4
2 Safety Precautions	5
2.1 Safety Precautions	5
2.2 Safety Guideline for Installation	6
3 Product Introduction	7
3.1 Introduction to B-Box HV System	7
3.2 B-Box HV Definitions	8
3.3 B-Box HV Configuration List	8
3.4 B-Box HV System Diagram	9
3.5 BCU Introduction	9
3.6 B-Plus-H Introduction	11
4 Electrical Properties of B-Box HV System	12
5 Cleaning and Maintenance	14
5.1 Cleaning	14
5.2 Storage and Maintenance	14
6 Disposal of Special Situations	14
6.1 Maintenance of battery Over-discharge	14
6.2 Force Majeure	14
7 Configuration List of B-Box HV with Different Inverters	14
7.1 B-Box HV Configuration List with SMA Sunny Island –On grid	14
7.2 B-Box HV Configuration List with KOSTAL–On grid	14
8 Common Problems and Solutions	15
9 Warranty	22

1 Overview

1.1 About this Manual

This Manual introduces B-Box H series product's information, guidance for use, safety precautions and common faults and troubleshooting. In the event of any abnormal fault or emergency, the user may contact our after-sales service center.

1.2 Target Products

This Manual applies to B-Box H series products.

1.3 Usage

B-Box H applies to the household energy storage field. When B-Box H is connected to different inverters, the user should use it with the designated inverter model by referring to the configuration list.

1.4 B-Box H series products Definitions

B-Box H: High-voltage household energy storage battery system.

B-Plus-H: Battery module. Battery module provides the energy, and sends the information about the cell voltage and cell temperature in the battery module to the upper-layer BCU. The nominal capacity of battery is 1.28kwh.

BCU: The battery management and control part, which is connected to the battery module underneath and to the inverter or BMU above.

1.5 Product Identification

The label describes the product identification attached on the product. For the safe usage, the user must understand the content of the label.

The content of label contains:

Product Name:

Model No:

Nominal Voltage:

Capacity:

Output power:

Operating temperature:

2 Safety Precautions

2.1 Safety Precautions

Warning Caution Reminding

The user should use BYD batteries in strict accordance with the User Manual and related documents;

BYD Lithium Battery Co., Ltd. will not guarantee or accept liability for a product installed and operated not in accordance to the guidance manual and resulting in an accident.



Warning

Please don't crush the battery, and always dispose it according to the safety regulations (please don't dispose it in fire or water);

The battery shall be charged at least every six months during storage;

The battery shall be stored at the ambient temperature within $-10\sim 50^{\circ}\text{C}$;

The battery shall work at the ambient temperature within $-10\sim 50^{\circ}\text{C}$;

The battery shall avoid being exposed to direct sunlight;

Ensure reliable grounding;

Reverse connection of positive and negative terminals is not allowed;

Before maintenance and when adding batteries, switch off the battery system and power off the inverter;

To avoid danger, DO NOT remove the BCU module when the system is in operation.

Maintenance must be carried out by qualified personnel;

Store according to requirements in user manual.

The number of stack-up layers of the batteries with packaging during the transportation and storage shall not be more than seven;

B-Box H can be used only in the household energy application, and is not allowed to be used in other industries, such as the medical equipment and automotive application.



Caution

Continuous operation of a damaged B-Box H will lead to a dangerous situation that may cause serious injury due to electrical shock., and B-Box H only can be operated when it is technically faultless and in an operationally safe state.

Regularly check the B-Box H for visible damage, making sure that all safety equipment is freely accessible at all times. If B-Box H is damaged, don't touch it. Please contact BYD after-sales service provider if a significant event message is displayed on the product or the inverter APP



Warning

When operating the system, avoid touching the battery terminal with any metal objects or human body. All work relating to electrical connections of the system shall be carried out by qualified personnel only.

Potentially hazardous circumstances such as excessive heat or electrolyte mist may occur under improper operating conditions, damage, misuse and abuse. The following safety precautions and the warning messages described in this section must be observed. If any of the following precautions are not fully understood, or if you have any questions, contact customer service for guidance.

Installation and maintenance personnel must operate according to applicable federal, state and local regulations as well as the industry standards regarding this product.

2.2 Safety Guideline for Installation



Warning

When install the system, avoid touching the battery terminal with any metal objects or human body.

All operations of B-Box H relating to electrical connection must be carried out by qualified personnel only.

B-Box H provides a safe source of electric energy when operated as designed.

Potentially hazardous circumstances such as excessive heat or electrolyte mist may occur under improper operating conditions, damage, misuse and abuse. The following safety precautions and the warning messages described in this section must be observed. If any of the following precautions are not fully understood, or if you have any questions, contact customer service for guidance.

The Safety Section may not include all regulations for your region; Installation and maintenance personnel must operate according to applicable federal, state and local regulations as well as the industry standards regarding this product

Installation personnel may not wear metal accessories, etc. in order to avoid short circuit and personal injury.



Warning

During loading, unloading and handling of the product, be cautious, and avoid accidents of product damage and personal injury due to the falling of product.

3 Product Introduction

3.1 Introduction to B-Box H System

This product is a high-voltage DC battery system, with the operating voltage range within 200~500V. It is applied to the household energy storage field and works together with high-voltage inverter, to realize the energy storage and release. Each set of battery of the system supports the serial connection of 5~9 battery modules, and parallel connection of 2~5 sets of battery systems.

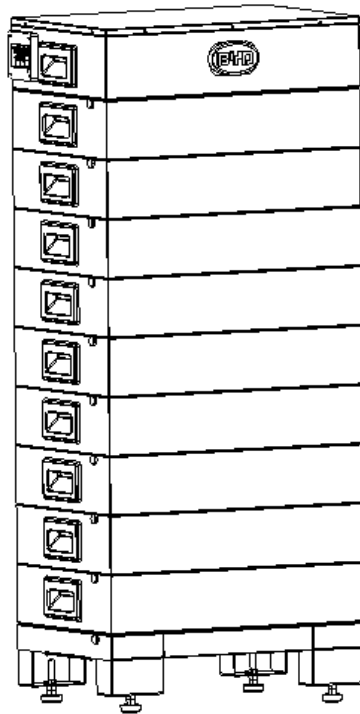

Product overview

Major Components:

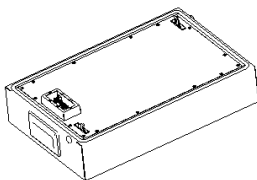

B-Plus-H

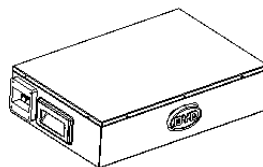

BCU

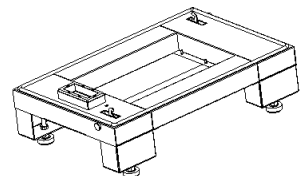

BASE

3.2 B-Box H Definitions

No.	Name	Definition
1	B-Plus-H	Battery module, consisting of battery pack (containing sixteen cells connected in series), BIC and structural shell. It is the minimal maintenance unit of the system.
2	BCU	Battery management and control part, which contains BCU and charge-discharge relay, and connected to the battery modules underneath and to the inverter or BMU above.
3	Base	The base of the whole system.
4	BIC	Battery detection unit, which is used to detect the voltage, temperature and other parameters of each cell in one battery module, and realizes communication with BCU.
5	B-Box H	The whole product, containing 5-9 battery modules, one BCU module, a base and other accessories.

3.3 B-Box HV Configuration List

No.	Name	Configuration			Energy (kWh)	Voltage
		BCU	B-Plus-H	Base		
1	B-Box H 6.4	1	5	1	6.4	200-282
2	B-Box H 7.7	1	6	1	7.68	240-338
3	B-Box H 9.0	1	7	1	8.96	280-395
4	B-Box H 10.2	1	8	1	10.24	320-451
5	B-Box H 11.5	1	9	1	11.52	360-500

3.4 B-Box H System Diagram

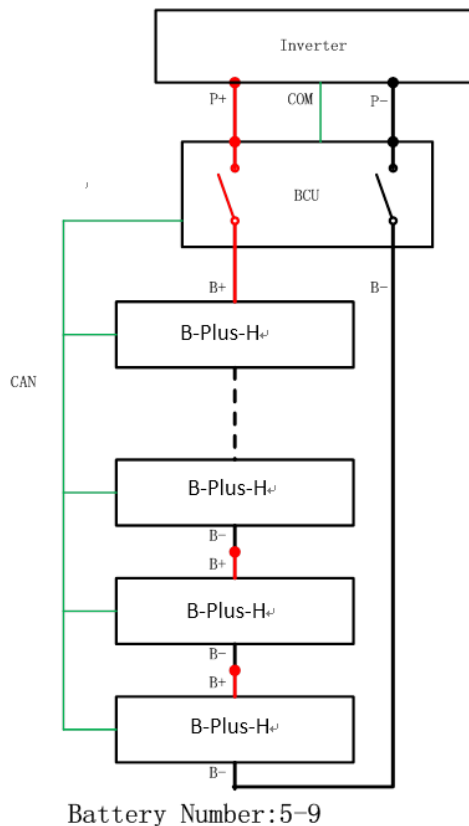

System Diagram

3.5 BCU Introduction

The battery management and control part, which contains BCU and charge-discharge relay, and connected to the battery modules underneath and to the inverter or BMU above.

3.5.1 BCU interface introduction [Left side]

Position	Designation	Left side terminals
A	Ethernet	
B	CAN (Inverter)	
C	Grounded	
D	P-	
E	P+	

3.5.2 BCU interface introduction [Right side]

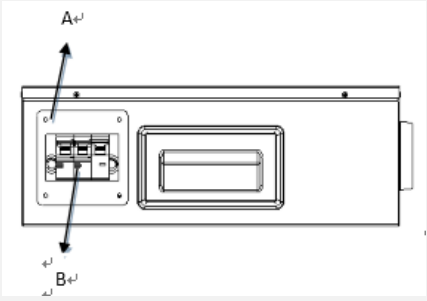
Position	Designation	Right side terminals
A	Air switch waterproof cover	
B	System Air switch	

3.5.3 BCU Functional Interfaces Definition

No.	Interface Name	Description
1	P+	The system positive terminal, connected to the inverter positive terminal for battery
2	P-	The system negative terminal, connected to the inverter negative terminal for battery
3	GND	Grounding terminal, connected to the ground.
4	Ethernet	Connected to the Ethernet, to complete the functions of communication and remote program update.
5	Inverter communication	Containing RS485, CAN, and enable signals, outputting 13V power.
6	System switch	The main switch of system, which can be operated manually and has the short circuit protection fun.

3.6 B-Plus-H Introduction

The electrical parameter design of battery module is as follows:

Product Model	B-Plus-H
Nominal voltage [V]	51.2
Capacity [Ah]	25
Stored energy [kWh]	1.28
Charge mode	Constant-voltage limited-current
Max. charge current	1C
Max. discharge current	Continuous at 1C, Peak at 2C, 5mins.
Operating temperature	-10°C~+50°C
Storage temperature	-10-50°C (<3 months, SOC: 20%-60%)
	-10-30°C (<12 months, SOC: 20%-60%)

4 Electrical Properties of B-Box H System

No.	Item	Description
1	Charge mode	Constant-voltage limited-current
2	Max. charge current	0.8C
3	Peak discharge current	2C, 5min
4	Max. discharge current	1C
5	Voltage detection accuracy of a single battery	5mV
6	Temperature detection accuracy	2°C
7	Current detection accuracy	1%
8	SOC calculation accuracy	5%
9	SOH calculation accuracy	5%
10	Balancing mode	Passive balancing
11	Inverter interface	CAN/RS485: The communication line of battery and inverter POWER: The power output wire, 13V; the maximum output power is 3W.
12	IP rating	IP55
13	Operating temperature	-10°C -- 50°C
14	Storage humidity	Less than or equal to 80%
15	Storage temperature	-10°C ~ 45°C (<3 months, SOC: 20%-60%) -10°C ~ 40°C (<12 months, SOC: 20%-60%)

a. Normally, the charge limited current is determined by the ambient temperature

No.	Temperature	Current
1	Less than -10°C	0
2	-10°C~0°C	0.2C
3	0°C~10°C	0.5C
4	10°C~50°C	0.8C
5	Greater than 50°C	0

b. Normally, the discharge limited current is determined by the ambient temperature

No.	Temperature	Current
1	Less than -20°C	0
2	-20~40°C	2C; if the actual discharge current is greater than 1.2C over 5min, the discharge limited current will be renewed to 1C. 2 hours later, it will be recovered to 2C discharge limited current.
3	40~50°C	0.5C
4	Greater than 50°C	0

5 Cleaning and Maintenance

5.1 Cleaning



Cleaning:

When you need to clean B-Box H, please shut down the system first.

When it is necessary to clean the shell of B-Box H, please remove the dirt with a soft dry brush or vacuum cleaner.

Don't use the liquids such as the solvent, abrasive materials or corrosive liquids to clean the shell.

5.2 Storage and Maintenance

As the battery capacity is 30% before transportation, the module needs maintenance after long-time storage. At the maintenance, first fully discharge the battery with 0.1C current, and then charge the battery to 30% with 0.1C current. Please refer to the table below for details:

The number of Maintenance Times

Temperature	Charging interval (Months)
25°C	18
35°C	12
45°C	6

6 Disposal of Special Situations

6.1 Maintenance of battery Over-discharge

If battery is over-discharged or rainy days continue, the battery may provide limited energy, and the user shall pay attention to the battery's backup time.

6.2 Force Majeure

Disastrous accidents, including thunder and lightning, flood, earthquake, fire, etc. may bring about unpredictable destruction to the whole system.

7 Configuration List of B-Box H with Different Inverters

7.1 B-Box H Configuration List with SMA Sunny Boy Storage

1 Phase on Grid

Inverter Type	B-Plus-H	BCU
SBS 2.5	5-9	1

7.2 B-Box H Configuration List with KOSTAL PIKO

3 Phase on Grid

Inverter Type	B-Plus-H	BCU
PIKO 6.0/8.0/10 BA	5-9	1

8 Common Problems and Solutions

Note:

1. The inverter may respond according to the alarms uploaded by the battery.
2. When something might endanger the battery system happens, the battery system will take appropriate protective measures, such as disconnecting the charge-discharge relays or opening the system switch; if the battery system automatically opens the system switch, please contact our Technical Support.
(The alarms generated by the battery system can be uploaded to the inverter, or be viewed on the webpage of battery system.)

8.1 Alarms Uploaded to the Inverter

No.	Alarm Name	Causes of Alarm	Solutions
1	Warning-Battery High Voltage	The cell voltage is too high.	Normal alarm, no further action required
2	Alarm-Battery High Voltage	The cell voltage is too high.	Normal alarm, no further action required
3	Warning-Battery Low Voltage	The cell voltage is too low.	Normal alarm, no further action required
4	Alarm-Battery Low Voltage	The cell voltage is too low.	Normal alarm, no further action required
5	Warning-Battery Low Temp	The cell temperature is too low.	Normal alarm, no further action required
6	Alarm-Battery Low Temp	The cell temperature is too low.	Normal alarm, no further action required
7	Warning-Battery High Temp	The cell temperature is too high.	Normal alarm, no further action required
8	Alarm-Battery High Temp	The cell temperature is too high.	Normal alarm, no further action required
9	Warning-Battery High Current Discharge	The discharge current is too high.	Normal alarm, no further action required
10	Alarm-Battery High Current Discharge	The discharge current is too high.	Normal alarm, no further action required
11	Warning-Battery High Current Charge	The charge current is too high.	Normal alarm, no further action required
12	Alarm-Battery High Current Charge	The charge current is too high.	Normal alarm, no further action required
13	Warning-BMS internal	Communication error	Normal alarm, no further action required
14	Alarm-BMS internal	Internal fault of battery system.	Contact the Technical Support.
15	Alarm-Precharge fault	Internal fault of battery system.	Contact the Technical Support.

8.2 Alarms Viewed by Logging in the Webpage

No.	Alarm Name	Causes of Alarm	Solutions
1	BatteryCommErr	Communication error of BCU and BIC.	Contact the Technical Support.
2	MonitorCommErr	Internal fault of battery system.	Contact the Technical Support.
3	BatteryPhaseErr	Internal fault of battery system.	Contact the Technical Support.
4	BreakLineErr	Internal fault of battery system.	Contact the Technical Support.
5	Discharge_OC1	The discharge current is too high.	Normal alarm, no further action required
6	Discharge_OC2	The discharge current is too high.	Normal alarm, no further action required
7	Discharge_OC3	The discharge current is too high.	Normal alarm, no further action required
8	Discharge_OC4	The discharge current is too high.	Normal alarm, no further action required
9	Cell_UV1	The cell voltage is too low.	Normal alarm, no further action required
10	Cell_UV2	The cell voltage is too low.	Normal alarm, no further action required
11	Cell_UV3	The cell voltage is too low.	Contact the Technical Support.
12	Discharge_OT1	The cell temperature is too high.	Normal alarm, no further action required
13	Discharge_OT2	The cell temperature is too high.	Normal alarm, no further action required
14	Discharge_OT3	The cell temperature is too high.	Contact the Technical Support.
15	Charge_OC1	The charge current is too high.	Normal alarm, no further action required
16	Charge_OC2	The charge current is too high.	Normal alarm, no further action required
17	Charge_OC3	The charge current is too high.	Normal alarm, no further action required
18	Charge_OC4	The charge current is too high.	Normal alarm, no further action required
19	Cell_OV1	The cell voltage is too high.	Normal alarm, no further action required
20	Cell_OV2	The cell voltage is too high.	Normal alarm, no further action required.

21	Cell_OV3	The cell voltage is too high.	Contact the Technical Support.
22	Charge_OT1	The cell temperature is too high.	Normal alarm, no further action required
23	Charge_OT2	The cell temperature is too high.	Normal alarm, no further action required
24	Charge_OT3	The cell temperature is too high.	Normal alarm, no further action required
25	Charge_UT1	The cell temperature is too low.	Normal alarm, no further action required
26	Charge_UT2	The cell temperature is too low.	Normal alarm, no further action required
27	Cell_OT	The cell temperature is too high.	Contact the Technical Support.
28	SeqStartTimeout	Internal fault of battery system.	Contact the Technical Support.
29	Battery Diff	Internal fault of battery system.	Contact the Technical Support.
30	BCUStart	Restart	If it occurs frequently, please contact the Technical Support.
31	BatteryLock	The cell voltage is too low.	Contact the Technical Support.
32	ZeroResetErr	Internal fault of battery system.	Contact the Technical Support.
33	ZeroResetFault	Internal fault of battery system.	Contact the Technical Support.
34	BIC_AddrCalc	Battery address matching	Normal alarm, no further action required
35	ChargeFault	Internal fault of battery system.	Contact the Technical Support.
36	DischargeFault	Internal fault of battery system.	Contact the Technical Support.
37	BatteryBreak	Internal fault of battery system.	Contact the Technical Support.
38	HardwareFault	Internal fault of battery system.	Contact the Technical Support.
39	PrechargeFault	Internal fault of battery system.	Contact the Technical Support.
40	DCBusFault	DC Bus short connected	Contact the Technical Support.
41	UpdateSuccess	Update succeed	Normal alarm, no further action required
42	UpdateFail	Update fail	Contact the Technical Support
43	SystemRestart	System restart	Normal alarm, no further action required

8.3 Log in the webpage

Enter correct IP address in the browser (IE, Google or Mozilla Firebox browsers are recommended), and then enter the account number and password to log in (the login ID: user; password: user).

- i. WIFI connection
First, connect the computer to the system's WIFI (name: BYD+ product serial number without the first 3 numbers (for example: product serial number is BYD100171708-00001, then WIFI name is BYD171708-00001, password: 123456789); then enter the IP: 192.168.5.1 in the browser, and enter the account number and password to log in.
- ii. LAN connection
Connect the battery system and the computer in the same LAN through a router, get the system's IP address on the router web page, then enter the system's IP address or its host name (e.g. BYD171708-00001) in the browser, and enter the account number and password to log in.
- iii. Direct connection with network cable
Directly connect the computer to the network interface of battery system with the network cable, set the computer's IP address to put the computer and the system on the same network segment, enter the IP: 192.168.6.1 in the browser, and enter the account number and password to log in.

The interface after successful login is shown below:

Some basic information like serial number, IP address will be displayed on the interface.

The screenshot displays the web interface for the BYD B-Box H. The interface features a header with the BYD logo and the slogan "Build Your Dreams" on the left, and "Clean Energy Change Life" on the right. A navigation menu on the left includes "Device Information", "Statistic Information", "Current Alarm", "History Alarm", "Run Data", and "Set Password". The main content area is titled "Device Information" and is divided into three sections: "Machine", "Board", and "Network".

Machine	
SN:	100171708-00001
Factory time:	1970-1-1 4:40:17
Version:	V1.001 R

Board	
SN:	test
Factory time:	1970-1-1 8:3:34

Network	
wlan0	192.168.5.1
eth0	10.5.78.45
eth0.2	192.168.6.1

Change Log

```
V1.000
1.Initial revision.
```

Copyright © 2017-2027 BYD Company Limited. All Rights Reserved.

Click the 'Statistic Information' on the left, the user can view the total charging and discharging energy, and the charging and discharging history.

BYD Build Your Dreams Clean Energy Change Life

B-Box H

- Device Information
- Statistic Information**
- Current Alarm
- History Alarm
- Run Data
- Set Password

Statistic Information

Total Information

Total Charge Energy:	0	WH
Total Discharge Energy:	0	WH
Total Cycle Count:	0	

Detail Information

No	Type	AH	WH	EnvTemp	BatTemp	StartTime	EndTime

CopyRight © 2017-2027 BYD Company Limited. All Rights Reserved.

Click the "Current Alarm" on the left, the user can view the current alarm of the system.

BYD Build Your Dreams Clean Energy Change Life

B-Box H

- Device Information
- Statistic Information
- Current Alarm**
- History Alarm
- Run Data
- Set Password

Current Alarm

No	Alarm Name	Main	Sub1	Sub2	Alarm Level	Alarm StartTime
1	Battery Break	0	0	0	3	1970-1-2 2:27:30
2	Hardware Fault	0	1	0	3	1970-1-2 2:27:30
3	Mointor COMM	0	1	0	3	1970-1-2 2:26:31

CopyRight © 2017-2027 BYD Company Limited. All Rights Reserved.

Click the “History Alarm” on the left, the user can review the history alarm of the system.

B-Box H

- Device Information
- Statistic Information
- Current Alarm
- History Alarm**
- Run Data
- Set Password

History Alarm

No	Alarm Name	Main	Sub1	Sub2	Alarm Level	Alarm StartTime	Alarm EndTime	Reason
1	BCU Comm	0	0	0	3	1970-1-2 2:27:31	1970-1-2 2:27:31	Restore
2	Mointor COMM	0	1	0	3	1970-1-2 2:26:31	1970-1-2 2:27:30	PowerDown
3	Hardware Fault	0	1	0	3	1970-1-2 2:27:30	1970-1-2 2:27:30	PowerDown
4	Battery Break	0	0	0	3	1970-1-2 2:27:30	1970-1-2 2:27:30	PowerDown
5	Start	0	0	0	1	1970-1-2 2:26:23	1970-1-2 2:26:23	Record
6	Start	0	0	0	1	1970-1-2 10:25:45	1970-1-2 10:25:45	Record

Buttons:

Copyright © 2017-2027 BYD Company Limited. All Rights Reserved.

Click the “Run Data” on the left, the user can view the run data of the system, including battery voltage, current and temperature etc.

B-Box H

- Device Information
- Statistic Information
- Current Alarm
- History Alarm
- Run Data**
- Set Password

Run Data

Array Num:

ArrayVoltage:	<input type="text" value="0.000"/>	V
PackVoltage:	<input type="text" value="869.787"/>	V
Current:	<input type="text" value="-0.200"/>	A
SOC:	<input type="text" value="50.000%"/>	
SOCWH:	<input type="text" value="4480"/>	WH
SOC4H:	<input type="text" value="12.500"/>	AH
SOH:	<input type="text" value="100.000%"/>	
SysTemp:	<input type="text" value="-50.000"/>	°C
MaxCellVol:	<input type="text" value="0.000"/>	V
MinCellVol:	<input type="text" value="0.000"/>	V
MaxCellTemp:	<input type="text" value="0.000"/>	°C
MinCellTemp:	<input type="text" value="0.000"/>	°C
MaxVolPos:	<input type="text" value="0"/>	
MinVolPos:	<input type="text" value="0"/>	
MaxTempPos:	<input type="text" value="0"/>	
MinTempPos:	<input type="text" value="0"/>	
Power:	<input type="text" value="0"/>	

Copyright © 2017-2027 BYD Company Limited. All Rights Reserved.

Click the “Set Password” on the left, the user can set the new password.

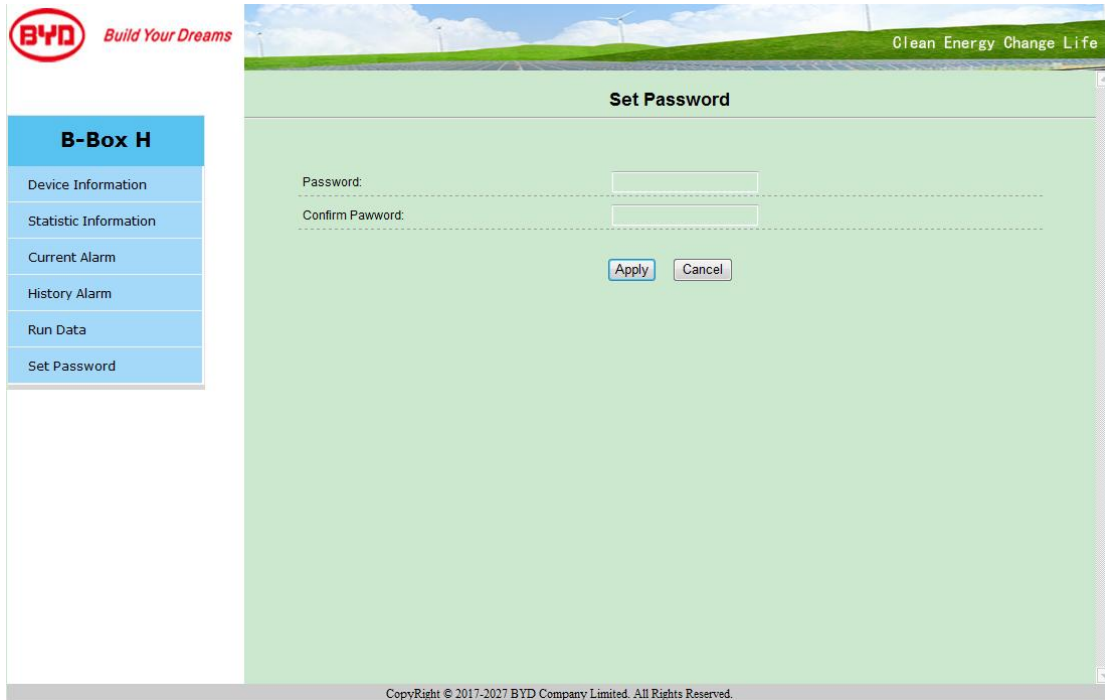

The screenshot displays the BYD B-Box H web interface. On the left is a navigation menu with the following items: B-Box H (highlighted), Device Information, Statistic Information, Current Alarm, History Alarm, Run Data, and Set Password. The main content area is titled "Set Password" and features two input fields: "Password:" and "Confirm Pawword:". Below these fields are "Apply" and "Cancel" buttons. The interface includes the BYD logo and slogan "Build Your Dreams" at the top left, and the slogan "Clean Energy Change Life" at the top right. A footer at the bottom reads "CopyRight © 2017-2027 BYD Company Limited. All Rights Reserved."

9 Warranty

BYD provides the warranty only when the product is installed and used according to the description in the user manual, installation manual or quality assurance documents.

To get the after-sales service in time, please input the product information into our after-sales service website. Thank you.

For technical problems and use requirement, please contact our installation company.

The following information is required for timely customer service.

Product type

Serial Number

Connected PV module type and number

Option equipment

Any problems please contact us by below address:

Contact us:

China

BYD LITHIUM BATTERY Co., LTD

Customer Service Mailbox: eubatterygrp@byd.com

Telephone: +86 0755 89888888

Address: No.1, Baoping Road, Baolong Industrial Town, Longgang, Shenzhen, 518116, P.R. China

Germany

EFT Systems GmbH

Customer Service Mailbox: info@eft-systems.de

Telephone: +49-9352 8523999

Address: Buchenstraße 37, 97816 Lohr am Main, Germany

Australia

Alps Power Pty Ltd

Customer Service Mailbox: service@alpspower.com.au

Telephone: +61478 140 287

Address: U201 15Chatham Road West Ryde NSW 2114 Australia